

AH Series Specification

AH3D1616UGR

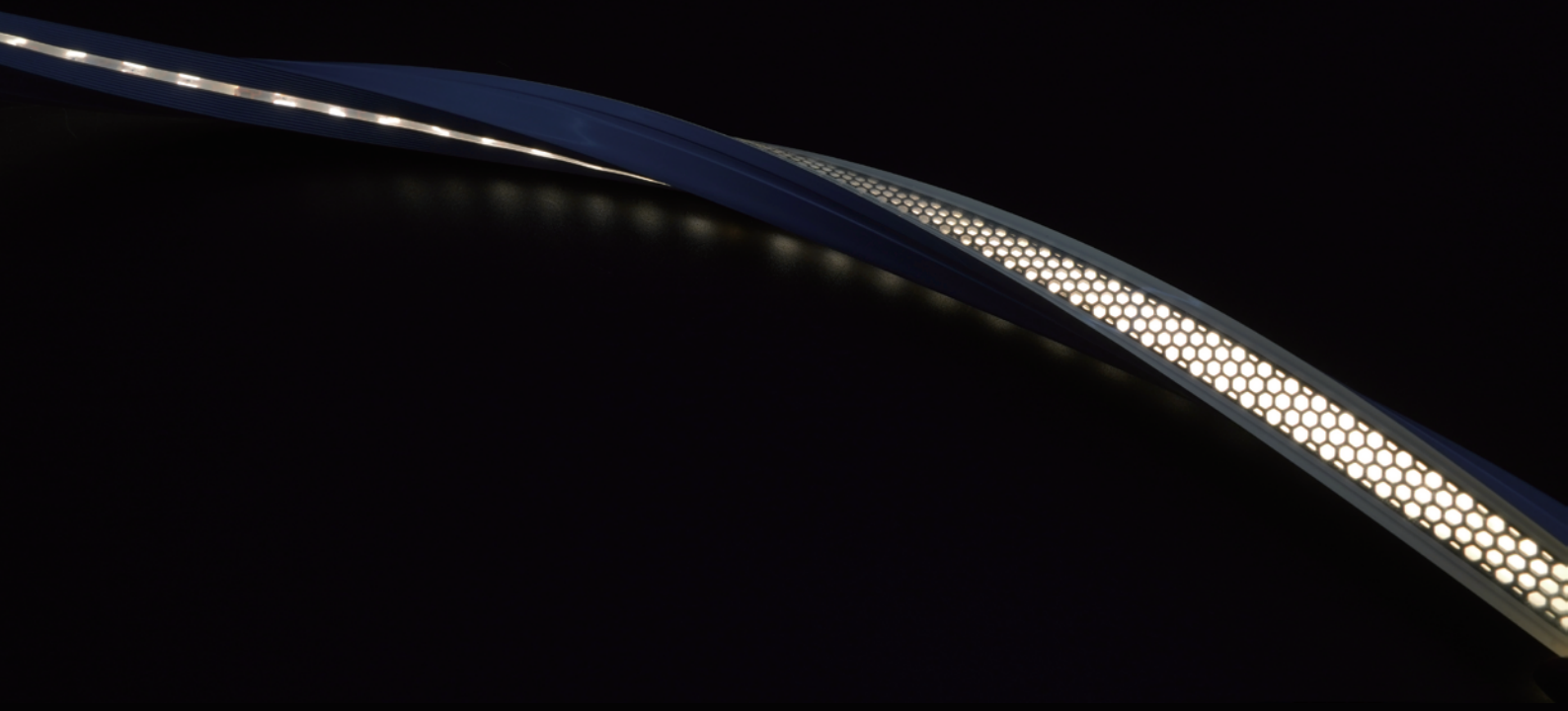
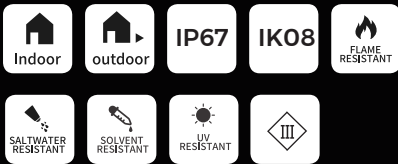

【Optical Features】

- **Light source:** High reliability light source;
- **Structure:** The lamp body shell is made of environmentally friendly, high-strength special materials;
- **Optical design:** unique optical light distribution structure design, uniform light emission on the surface without shadows;
- **Anti-glare Index:** UGR \leq 19
- **Environmental characteristics:** salt resistance, acid and alkali corrosion resistance, UV resistance;
- **Working/storage temperature:** Ta: -20-50 C / 0 C ~ 60 C ;
- **Product application:** Indoor or Outdoor;
- **5 years warranty or working life =60000H,whichever comes first.**

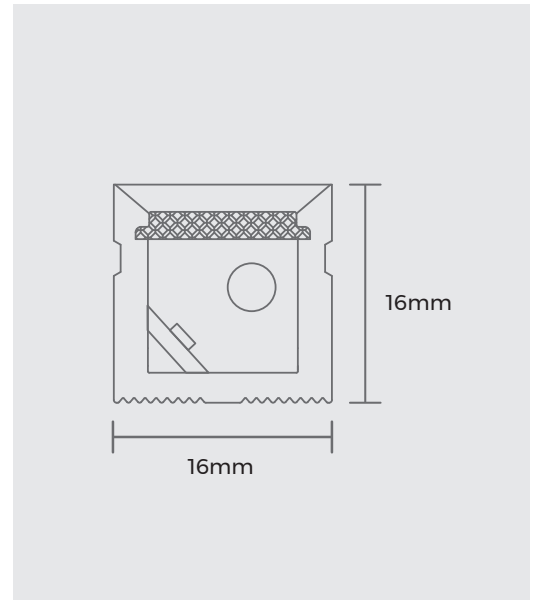

【Basic Parameters】

White - 24V

Model	CCT/colors	Color Temperature Range	CRI	Input voltage (V)	Rated current (A/m)	Rated power (W/m)	Maximum power (W/m)	Lumens (LM/m)	Standard Length	Remark
AH3D1616UGR-9XW24 CSU050CC0500 -CV10-ENP-ESD	2300K	2150-2400K	>90	24	0.416 (0.13A/ft)	10 (3.05W/ft)	11 (3.3W/ft)	110 (34LM/ft)	5000mm (16.4ft)	Free Cutting
	2700K	2600-2800K						135 (41LM/ft)		
	3000K	2800-3200K						135 (41LM/ft)		
	4000K	3800-4200K						150 (46LM/ft)		

Note:

1. The above data is the testing result of 1M standard product;
2. The luminous flux is allowed to have an error range of -15%~+15%;
3. The above parameters are all typical values.

【Product mechanical parameters】

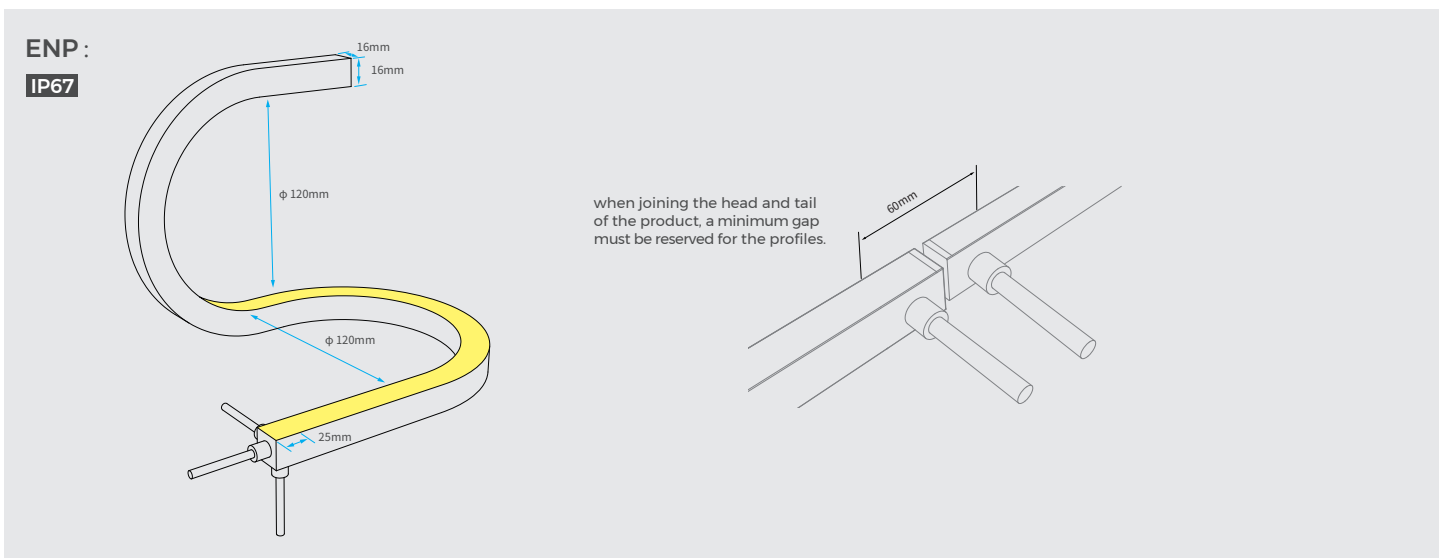

[Accessory information]

Flat mounting clip

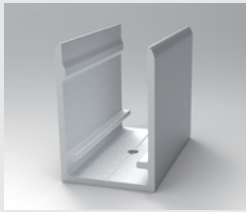

Model: AS-GMS/T1616A-25
Size: 25x18.6x21.1mm

Screw Model: KA3.5*30
Screw QTY: 1 PCS

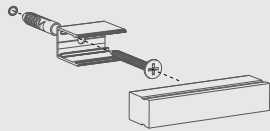
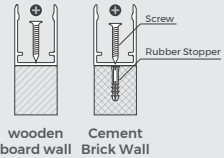
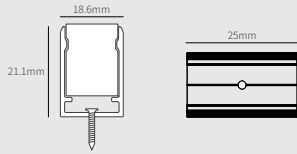

Flat mounting aluminum groove

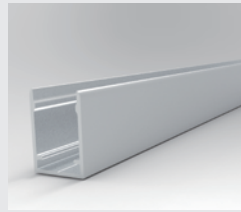

Model: AS-GMS/T1616A-1000
Size: 1000x18.6x21.1mm

Screw Model: KA3.5*30
Screw QTY: 3 PCS

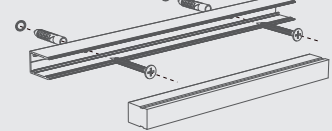
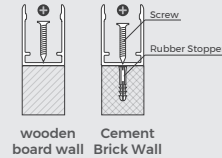
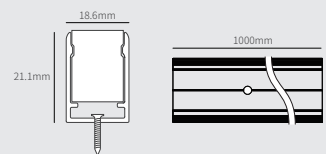

Clip with reserved wire outlet



Model: AS-GMS/T1616A1-25
Size: 25x19.2x41.8mm

Screw Model: KA3.5*30
Screw QTY: 1 PCS

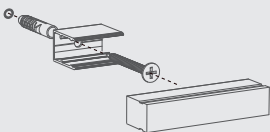
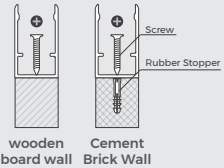
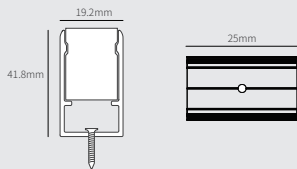

Aluminum groove with reserved wire outlet

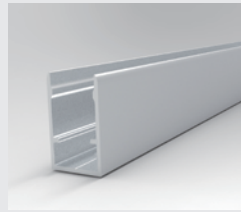

Model: AS-GMS/T1616A1-1000
Size: 1000x19.2x41.8mm

Screw Model: KA3.5*30
Screw QTY: 3 PCS

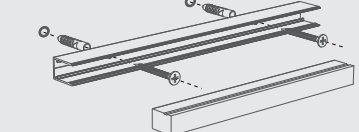
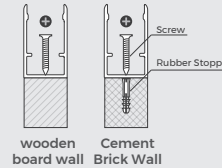
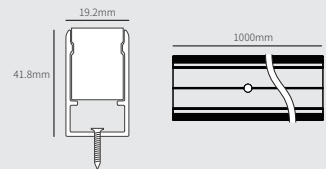

Moldable carrier

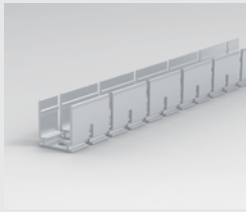

Model: AS-AFS(T)1616M-1000
Size: 1000x18.6x21.1mm

Screw Model: KA3.5*30
Screw QTY: 8 PCS

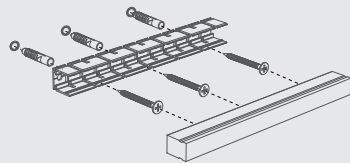
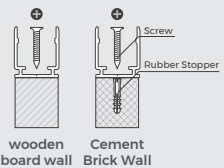
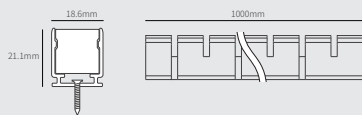

Moldable carrier

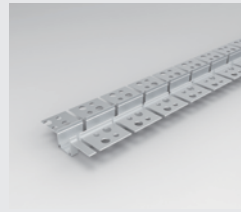

Model: AS-AFS(T)1616A5-1000
Size: 1000*58.7*20.7mm

Screw Model: KM3*12
Screw QTY: 20 PCS

Denging: $R \geq 400mm$

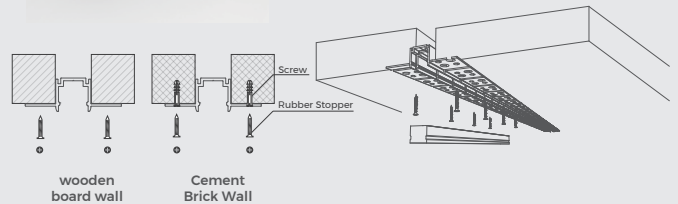

【Product Wiring Schematic】

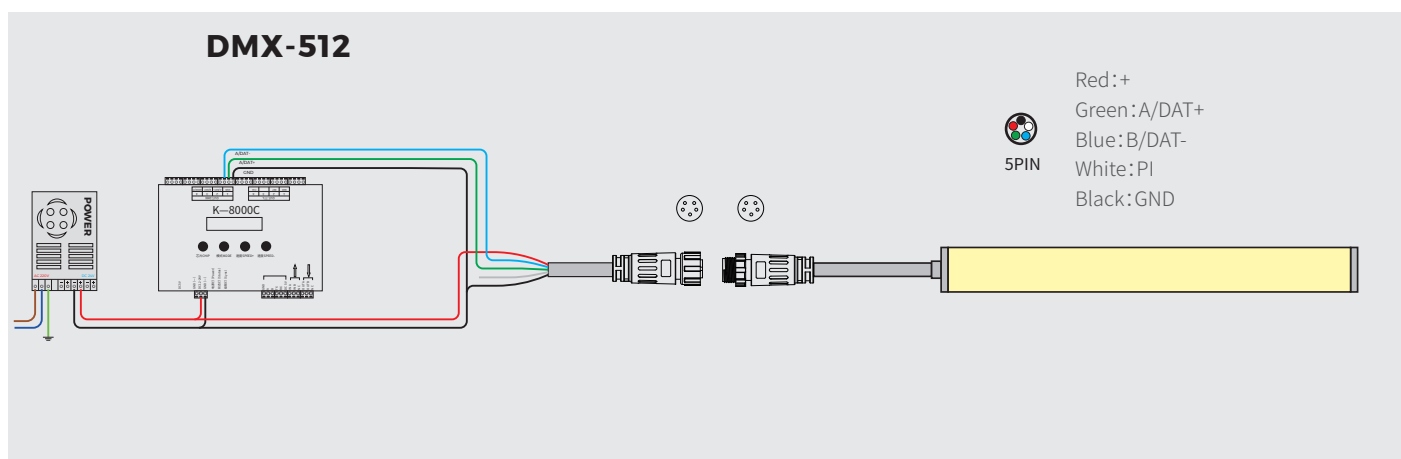
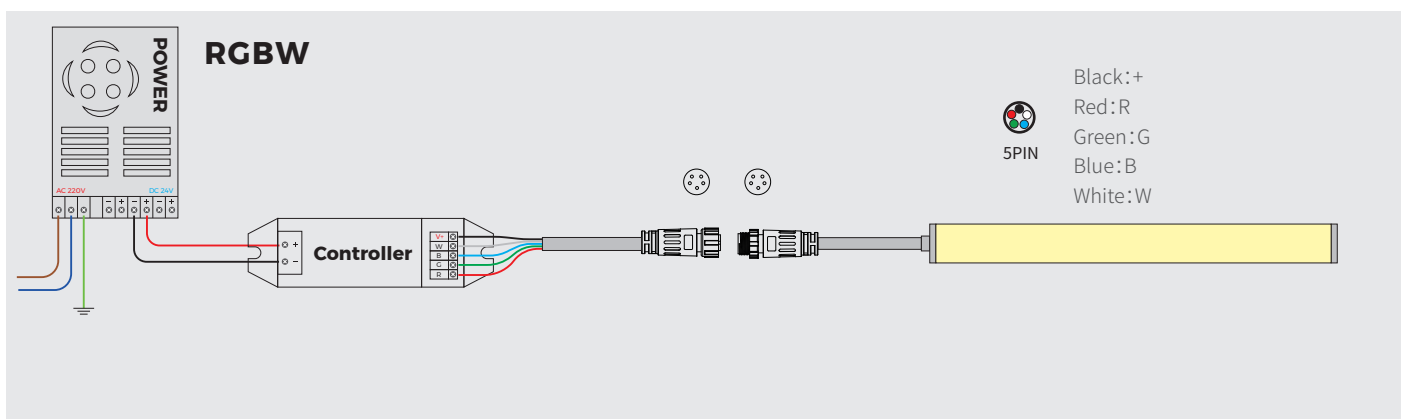
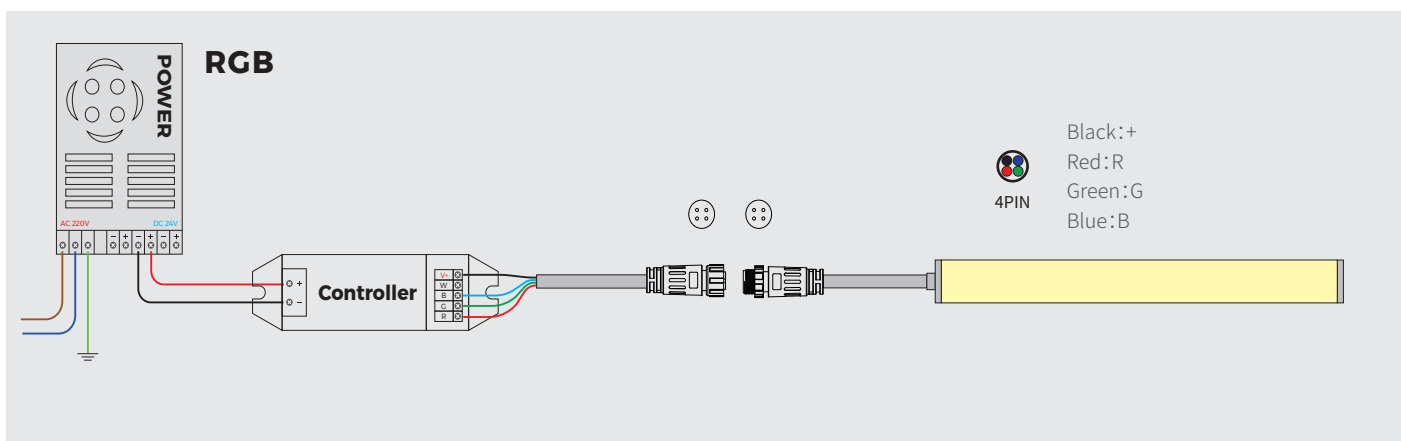
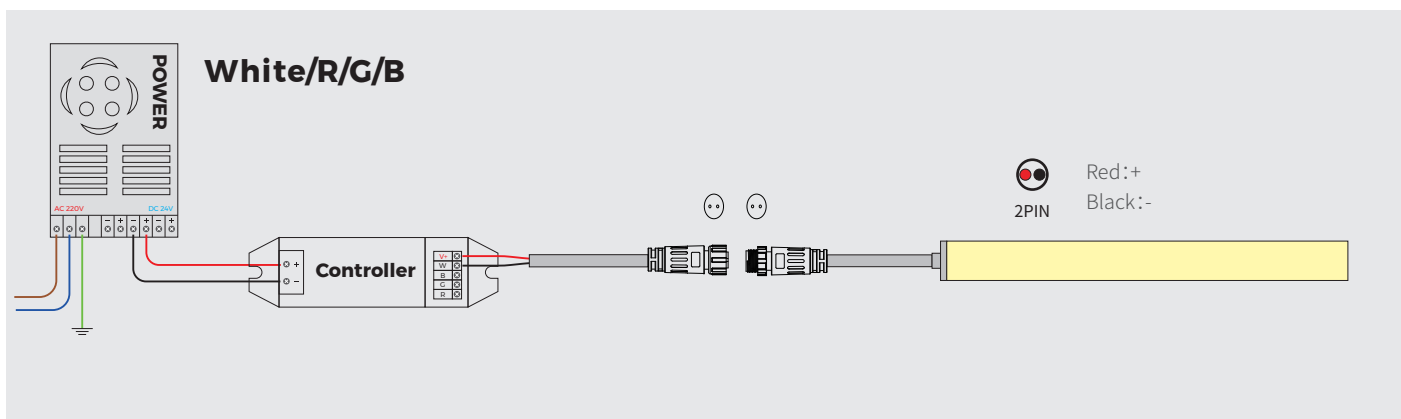

【Packing information】

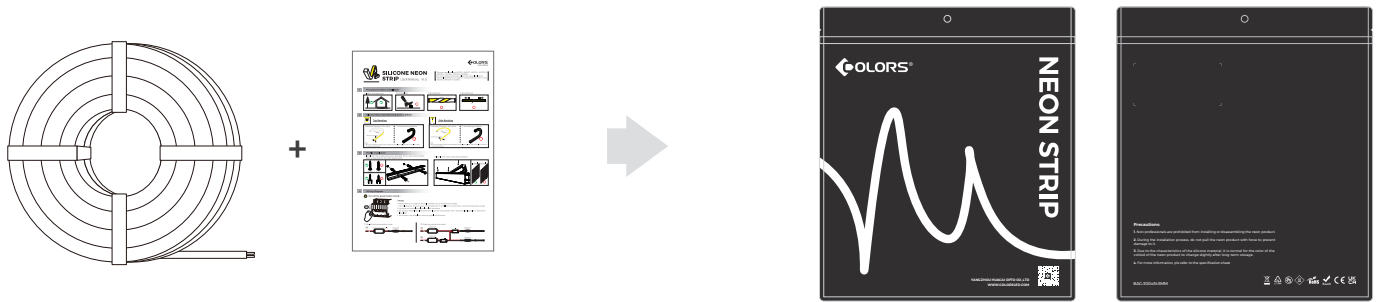

【 Warranty and After-sales Service 】

Product Warranty Statement

Thank you for choosing COLORS products. In order to protect your rights, enhance product experience, and improve service quality, we have established the following “Product Warranty Statement”. This statement applies to all LED strips and neon strips produced by COLORS.

I. Warranty Commitment

COLORS solemnly promises that for products that meet the following warranty conditions and are within the warranty period, we will provide a “new-for-old” service, which means replacing products with the following faults:

- 1.Functional Faults: The light source fails to work normally (due to materials or craftsmanship resulting in the inability to illuminate).
- 2.Cosmetic Faults: Severe cosmetic issues of the product itself when it has been unsealed but not used.

II. Warranty Exclusions

The following are not covered by the warranty:

- 1.Light color coordinate drift (shift), luminous flux degradation, and changes in product appearance and color caused by long-term continuous use.
- 2.Faults caused by incorrect use, installation, or modification by the user.
- 3.Applications in mines, special equipment, and other specialized lighting fields without sufficient communication with our company.

III. Additional Terms of Warranty Service

- 1.Products applying for warranty service should be installed and used normally, and their configuration must be consistent with that at the time of factory shipment.
- 2.Users must follow the installation instructions and product specifications provided by COLORS to ensure that the product is used reasonably in the appropriate temperature and application environment.
- 3.COLORS's warranty products are only suitable for general lighting and decorative lighting applications.
- 4.COLORS will only bear the “new-for-old” service for products that meet the conditions and will not cover any related logistics, labor costs, or any other direct or indirect expenses.
- 5.COLORS ensures that the replacement new products meet or exceed the performance and specifications of the original products and reserves the right of final interpretation.
- 6.For the warranty terms applicable to other agreed usage scenarios, please refer to the company's contract for details.

Please keep this statement properly for use as a reference for warranty services when needed. If you have any questions, please feel free to contact us. Thank you for your support and trust!

【 Reliability Testing 】

test item	Classification	Reference	Test method or condition
Safety test	Mechanical strength	IEC 60598-1; IEC 60598-2-21	The hammer spring Impact energy 0.7J
	IP	IEC 60598-1; IEC 60598-2-21	IP67
	Winding Test	IEC 60598-1; IEC 60598-2-21	φ150mm cylinder, 60N pull, winding 10 times at (-25°C±2°C), and 10 times after(-15°C±2°C, 16h).
	Cold Bend Test	IEC 60598-1; IEC 60598-2-21	wound on mandrel, low-temperature (-15°C±2°C, 16h), around the mandrel for two turns
	Cold Impact test	IEC 60598-1; IEC 60598-2-21	Low-temperature (-15°C±5°C, 16h), hammer falls from a height of 100mm.
	Insulation Resistance	IEC 60598-1; IEC 60598-2-21	≤ 2MΩ
	Electrical strength	IEC 60598-1; IEC 60598-2-21	500V
Mechanical reliability testing	Bending test	Colors	Each 200mm, bending up and down 100 times
	Bending test	Colors	Each 200mm, bending left and right 100 times
	Torsion test	Colors	Twist clockwise 5 times and then release, repeat 200 times
	Disassembly and assembly test	Colors	Repeat disassembly and assembly, 10 times
Environment Reliability testing	High temperature storing test	IEC 60068-2-2	80°C, 168h
	Low temperature storing test	IEC 60068-2-1	-40°C, 168h
	High temperature and Humidity impact	IEC 60068-2-78	60°C, 85%RH
	Salt Spray test	IEC 60068-2-11	5% salt solution concentration, 24h
	IK	IEC 62262	5 times of impact on each exposed surface
	Lifetime aging test	Colors	35°C, 6000h
	switch test	Colors	10s On, 10s Off, 10000 times

【 Notes 】

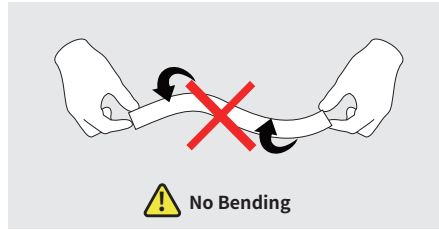
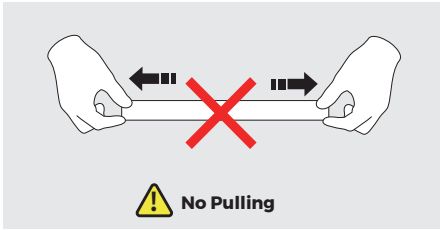

1. Safe Electricity Use

- ① Non-professionals are prohibited from installing or disassembling the light strips.
- ② Ensure the driver's voltage matches the product to avoid overload or short circuit.
- ③ The IP67 wiring system that comes with the product must be selected to prevent electric leakage.
- ④ Use an isolated power supply to drive the LED light strips. The ripple of the constant voltage source must be less than 5%. Capacitor-drop, non-isolated, or similar types of power supplies are not allowed.
- ⑤ In practical applications, the power supply should have a 20% margin (it is recommended to use only 80% of its power) to ensure sufficient voltage for driving the product.
- ⑥ Operate with caution. Do not touch the AC power terminals when the power is on to prevent electric shock.
- ⑦ Pay attention to the positive and negative poles of the power cord; do not connect them incorrectly. Verify that the voltage of the power supply matches the product to avoid product damage.

2. Installation Environment

- ① Products with IP67 protection are not suitable for underwater use in swimming pools. For underwater applications, use dedicated underwater products.
- ② Avoid high-temperature environments (e.g., near heaters, fire sources) and areas with corrosive gases/liquids.

3. Installation Precautions

- ① Use dedicated profiles or clips for fixation; avoid bending or pulling the wires.
- ② Ensure firm contact during wiring to prevent faults caused by poor connections.
- ③ During installation, avoid scratching, twisting, or irregularly bending the product, as this may cause irreparable damage.
- ④ To ensure the light strip's lifespan and reliability, do not bend it beyond the minimum bending radius. An excessively small bending radius will damage the product.
- ⑤ If the actual application length exceeds the specified usable length, the light strip may experience overload, overheating, or uneven brightness.
- ⑥ Do not use any acidic or alkaline adhesives (including but not limited to glass glue) to fix the product.
- ⑦ Due to structural differences, products of different sizes may have slight color deviations under the same color temperature. Confirm this before use.
- ⑧ Products with IP68 protection cannot be cut or processed by yourself.
- ⑨ For unwinding and placing engineering-packaged neon products during construction, use a pay-off stand to avoid damage from pulling forces.
- ⑩ During construction and installation, do not use adhesives (e.g., 502/705) that react with silicone. Silicone sealant is recommended for bonding.

4. Usage and Maintenance

- ① Disconnect the power supply when the product is not in use for a long time to extend its lifespan.
- ② Ensure proper sealing for products stored long-term or remaining after cutting; avoid exposure to organic environments containing aldehydes/benzenes.
- ③ To protect eyesight, avoid staring at the light-emitting surface of the lit light strip for a long time.
- ④ When installing and using the product, ensure the entire product is in the same environmental conditions to prevent uneven color changes of the product's colloid caused by different exposure levels or environmental differences.

5. Environmental Handling

- ① Discarded light strips must be recycled in accordance with e-waste regulations; do not discard them randomly.
- ② When replacing light strips, prioritize degradable or energy-saving products.

6. Other Statements

- ① For mass production, 1-2 splices per 5 meters are allowed.
- ② Due to the characteristics of silicone material, slight color changes in the colloid of neon products after long-term use are normal.
- ③ When using dimmers (e.g., Triac) and dimming power supplies with the product, conduct compatibility tests between the product, dimmer, and dimming power supply to ensure full adaptation. For any issues, please contact COLORS for professional technical support.